

EN

# GEM-OX-C installation guide

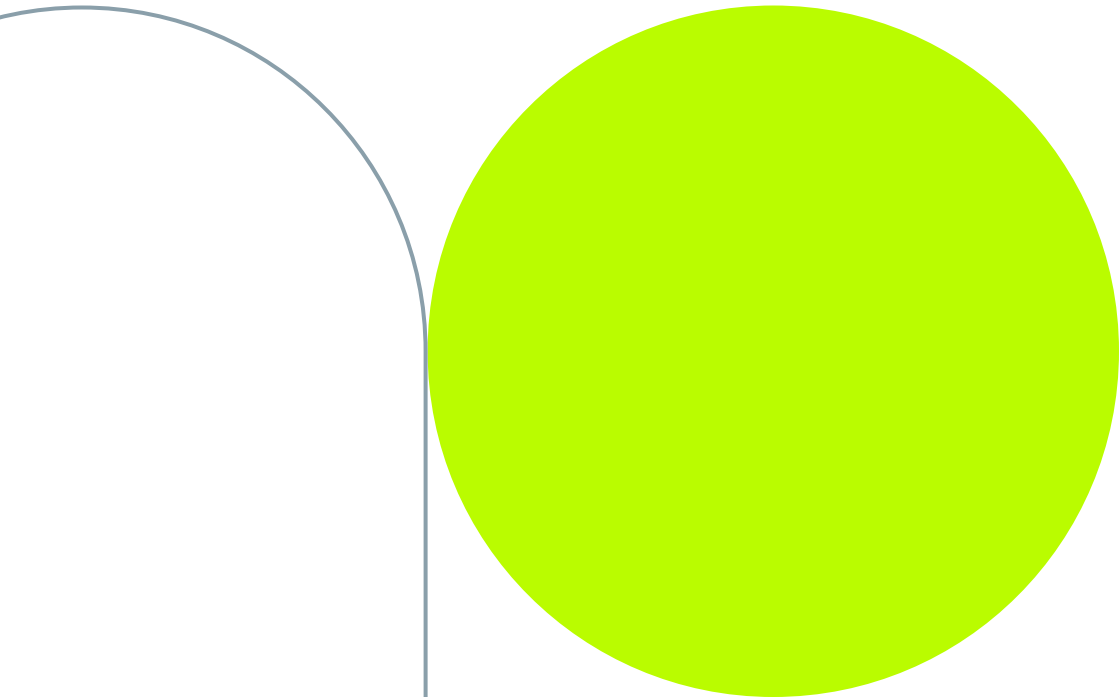

**GemOne®**



# Content

<b>General information</b>	<b>4</b>
<b>Technical specs</b>	<b>5</b>
<b>Dimensions</b>	<b>6</b>
<b>Wiring</b>	<b>7</b>
<b>Wiring guidelines</b>	<b>8</b>
B+	8
ACC (Digital input 1)	8
Digital input 2	9
Digital input 3	9
<b>Schematic</b>	<b>10</b>
<b>Antennas</b>	<b>11</b>
<b>LEDs</b>	<b>12</b>
Navigation LED	12
Status LED	13
<b>Deep sleep mode</b>	<b>14</b>
<b>Input filtering</b>	<b>15</b>
<b>FAQ / Troubleshooting</b>	<b>16</b>
<b>Support</b>	<b>20</b>

# General information

The GemOne tracker is a smart tracker, which combines basic tracking (location and usage based on its inputs) with advanced functionalities (enabling geofences and impact detection, accelerometer...).

The tracker is IP67, which means it can withstand dust and water. Installations should not be protected from dust, rain or splashes of water. See the installation instructions for more information.



# Technical specs

## Power

**Working voltage:** 10 - 97V DC with over voltage protection  
**Battery:** 1800 mAh Ni-MH internal backup battery

## Physical specifications

**Dimensions:** 72.5 × 73 × 27.3 mm  
**Weight:** 205g  
**Ingress protection:** IP67  
**Operating temp.:** -40°C to +85°C  
**Conformity & Certifications:** CE/RED, E-Mark, EAC, RoHS

## GSM (data)

Internal high gain antenna  
2G Quad-band 850 / 900  
1800 / 1900 MHz  
SMS / TCP / UDP  
Internal 128MB flash memory  
for data

## GNSS (positioning)

**Receiver:** GPS, GLONASS,  
GALILEO, BEIDOU,  
SBAS, QZSS,  
DGPS, AGPS  
**Antenna:** Internal high  
gain antenna  
**Accuracy:** < 3 meters

## Connectivity

Bluetooth 4.0 + LE  
2 status LEDs  
1 CAN-bus  
4 digital inputs \*  
2 digital outputs \*  
2 analog inputs \*  
1-wire interface + power  
(\* Shared IO - depending  
on configuration







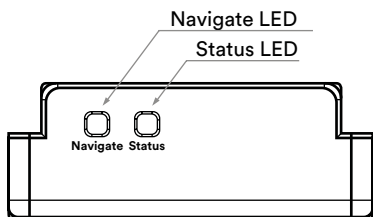
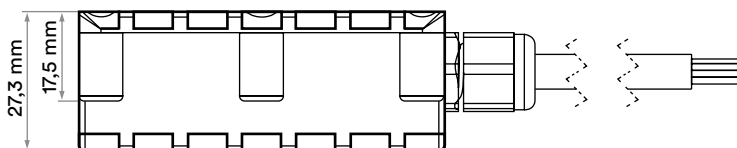
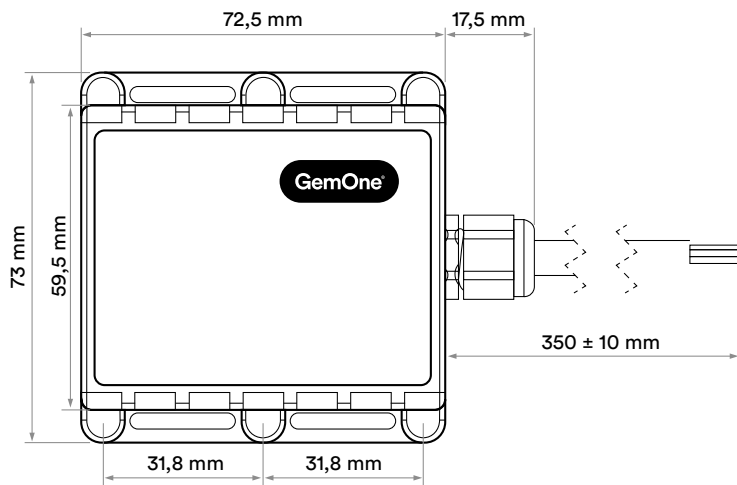



## Supported peripherals

Built-in accelerometer  
RFID reader

# Dimensions



# Wiring

Wire color		Connection	Description
Red		B+	Attach to permanent 10-97V DC supply via a 1A fuse (mandatory)
Black		Ground (GND)	Attach to the ground or '-' pole of your machine or battery (mandatory)
Yellow		1 WIRE POWER	Do not connect Reserved for future use
Green/White		CAN-H	CAN interface - CAN High (without internal 120 Ohm termination)
White		CAN-L	CAN interface - CAN Low (without internal 120 Ohm termination)
Grey		DIN2	Digital input 2: Hour counter - 0 up to 150V tolerance - Din2 0-8.5V is logic '0', Usage off - Din2 8.5-150V is logic '1', Usage on
Orange/White		DOUT1/DIN3	<b>Access control enabled:</b> Digital output 1: Access control feedback output Open-drain with I <sub>max</sub> = 300mA <b>Access control disabled:</b> Digital input 3: Optional - 0 up to 150V tolerance - Din3 0-8.5V is logic '0', Input off - Din3 8.5-150V is logic '1', Input on
Purple		DOUT2/DIN4	<b>Access control enabled:</b> Digital output 2: Access control relay output Open-drain with I <sub>max</sub> = 300mA <b>Access control disabled:</b> Digital input 4: Optional - 0 up to 150V tolerance - Din4 0-8.5V is logic '0', Ignition off - Din4 8.5-150V is logic '1', Ignition on
Green		DIN1 (Ignition)	Digital input 1: Ignition input (mandatory) - 0 up to 150V tolerance - Din1 0-8.5V is logic '0', Ignition off - Din1 8.5-150V is logic '1', Ignition on
Blue		1 WIRE DATA	Access control data

# Wiring guidelines

- **B+**

The tracker must always be powered, preferably directly to the battery of your machine. It must be connected before the emergency switch and key switch to ensure a continuous power supply.

If the tracker is not powered continuously, location of your machine, access control and other features may not work as expected.

- **Digital input 1**

Digital input 1 represents the ignition input of our tracker. It is mandatory to connect it to the ignition of your machine. The tracker depends on this input to regulate sleep mode, access control and other advanced features.

The signal must be:

- Low when the machine is off (<8V)
- High when the machine is switched on (>8V) - before the engine is running
- High while the engine is running
- Low when the machine is turned off

- **Digital input 2**

Digital input 2 represents the hour counter, but - unlike digital input 1 - it is not mandatory to connect it to your machine.

You are free to connect it to any point in your machine which monitors the usage:

- Physical hour counter with on/off input
- Signal indicating when the engine is on/off
- Pneumatic or hydraulic pumps on/off
- Seat switch
- Foot pedal

If none of the above suggestions are available on your machine, you can opt to base the hours calculation on the ignition input in our cloud platform.



- **Digital inputs / Digital outputs**

When access control is disabled:

The orange/white and purple cables are configured as digital input 3 and digital input 4, respectively. These digital inputs are optional and can be used to capture additional information from your machine.

Some machines place the main breaker or the emergency switch between the ‘-’ pole of the battery and the chassis. This will cause invalid signals on all inputs. To prevent this from happening, digital input 3 can be wired to the chassis. More information can be found in section [Input filtering](#).

Please make sure that digital inputs 3 and 4 are only wired to an external input (e.g. seat contact ...) if the tracker is not configured for access control. If in doubt about the tracker configuration, contact your platform administrator to verify.

When access control is enabled, digital inputs 3 and 4 are occupied, and should not be used as an input.

When access control is enabled:

The orange/white and purple cables are configured as digital output 1 and digital output 2, respectively. In that case, Digital output 1 is used as the access control feedback output.

Digital output 2 must be wired to the relay. For more information about access control and its installation, we refer to our GEM-ACC-KP installation guide.

- **CAN**

The CAN lines must be terminated with a 120 Ohms resistor if this termination is not provided by the machine. Contact your machine’s technical documentation for more information.

Always connect the CAN interface if possible, even if your specific machine type is not supported yet. This will allow for software updates once support for your machine is added without changing the existing installation.

# Schematic

You can find the wiring scheme of the basic installation below. With this installation, the ignition and hour meter will be captured. Digital input 3 and 4 can be used to capture additional information from your machine.

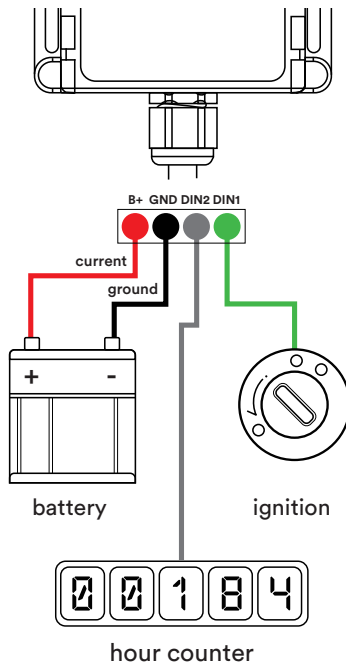

B+, GND and DIN1 are mandatory for every installation.

## Access Control

Our GemOne trackers can be equipped with access control accessories to add driver identification and access control to your existing fleet. For more information and guidelines on the installation, we refer to our GEM-ACC-KP installation guide.

# Antennas

The tracker has an internal GNSS (GPS) and GSM antenna.

For the antennas to work correctly, the tracker should be mounted with the GemOne logo and the LEDs towards the open sky (unobstructed by metal

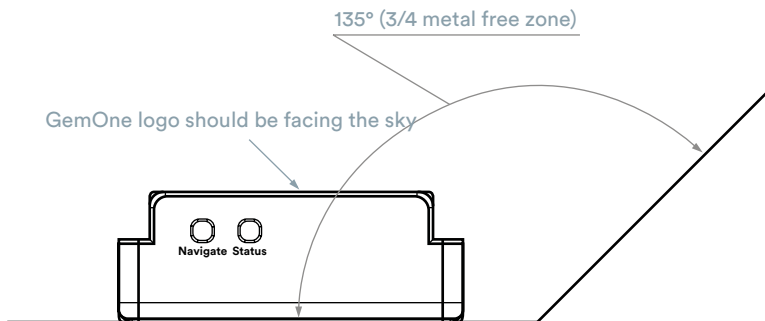

It is not important in which direction the tracker is installed. The most important instruction is that the GSM and GNSS antenna have a good open view.

# LEDs

The tracker has two LEDs: a navigation LED and a status LED. Both LEDs have a green color.

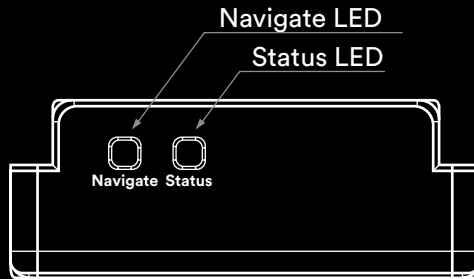

## Navigate LED

Behaviour	Meaning	OK?
Permanently switched on	GPS signal is not received	No
Blinking every second	Normal mode, GPS is working	Yes
Off	GPS is turned off because: Deep sleep mode Or GPS antenna short circuited	Yes  No

If the Navigate LED is off, check the status LED (see next page) to make a distinction between Deep sleep mode and GPS antenna short circuited. The latter won't happen often.

## Status LED

Behaviour	Meaning	OK?
Blinking every second	Normal mode	Yes
Blinking every 2 seconds	Deep sleep mode	Yes
Blinking fast for a short time	Modem activity	Yes
Blinking fast constantly	Boot mode	Yes

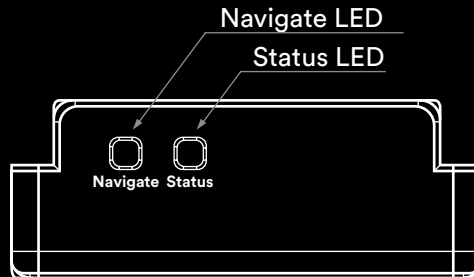

- If both Navigate LED and Status LED are off, please check if the device is receiving the working voltage, which is 10-97V DC.
- If Navigate LED is OFF and Status LED is blinking every two seconds, the device is in deep sleep mode so that is normal and should not require any additional checks.
- If Navigate LED is OFF and Status LED is blinking every one second, then the GPS antenna is short circuited. Please contact support in that case.

# Deep sleep mode

The tracker is configured to use deep sleep mode to preserve the vehicle's battery charge. If no movement is detected and the ignition is off (digital input 1), after 10 minutes it will go into deep sleep mode. This means that the GPS module is switched off and only the ignition (digital input 1) is monitored for changes. The tracker also sends a message every hour if no activity is detected.

If the tracker is in deep sleep, we can still reach it via SMS (e.g. to wake up ...).

Deep sleep mode is switched off when the internal accelerometer detects movement or when the ignition is switched on.

# Input filtering

Some machines put the main breaker between the '-' pole of the battery and the chassis (ground wire). In that case, the machine is always connected to the '+' pole of the battery. This could cause a voltage on the inputs of our telematics module, which will be interpreted as activity (eg. ignition on, hour counter running, ...)

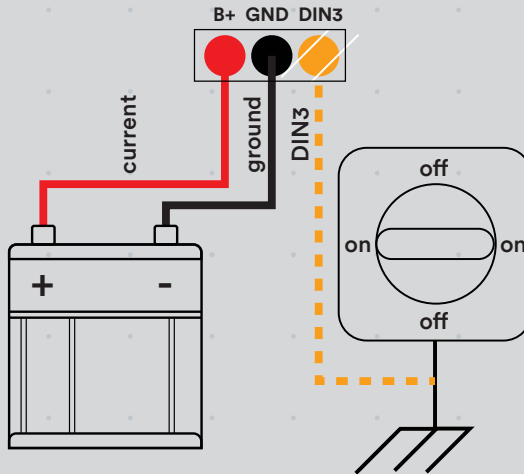

To detect this situation, the tracker needs an additional connection (DIN3 - orange/white or DIN4 - purple) to the chassis. This input can detect invalid signals and will allow the cloud platform to filter other invalid inputs as well. Make sure you enable input filtering in the cloud platform on digital input 3/4 when this feature is needed.

# FAQ / Troubleshooting

- **None of the LEDs turn on.**
  - Verify if the tracker has power between B+ (yellow) and GND (black). The tracker needs a voltage between 9-90V
  - Verify if the 1A fuse is still intact
  - Make sure that the ignition input (ACC) is wired correctly

- **The tracker sends data but I can't see the location of the vehicle.**

Verify if the installation was done according to the guidelines. The GemOne logo should face the open sky, without metal obstructions. See 'Antennas' section for more information.

The GPS signal isn't always available inside so location tracking may not work indoors.

- **Ignition or hour counter input stays high - even if the machine is not running.**

Check if the ignition is actually used by the operators. In a lot of cases, the emergency switch is used instead of the ignition switch. On some machines, this disables the machine but keeps the ignition signal high. The installation must match the actual usage of the machine. If the emergency switch is used instead of the ignition switch, then it might be better to use another point in the machine. Please consult your machine's technical documentation for more information.

The same applies to all other inputs including digital input 2 (hour counter).



- **My machine has multiple control panels - which ignition signal do I use?**

Some machines have multiple control panels, each with its own key switch and/or emergency stops (eg. one on the platform and another on the ground control panel). In that case, you have to make sure that the ignition digital input of our tracker measures both signals. Some machines have a combined signal available, please consult your schematic and manual.

If no combined signal is available in the machine, one can be constructed using two diodes:

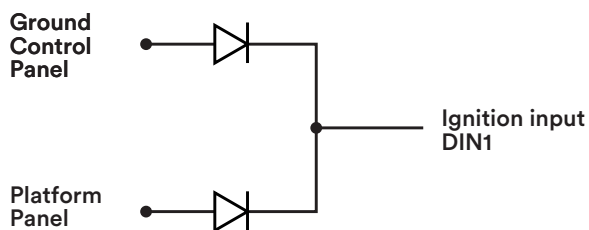

Make sure you use suitable diodes for your application (maximum voltage, ...). Commonly used diode types are: 1N4005 or 1N4007

- **There is no CAN data coming in even though the CAN bus is connected.**

Successfully reading out CAN data depends on multiple things:

- Make sure CAN readout on your machine type is supported. Contact your sales representative to verify.
- Make sure your tracker is configured correctly in the cloud platform. Consult the cloud platform documentation for more details.
- Verify if CAN-L (white) on the tracker is connected to the CAN-L line of the machine. Verify if CAN-H (green/white) on the tracker is connected to the CAN-H line of the machine. Consult your machine documentation for more info.
- Verify if an additional 120 Ohms termination resistor is required between CAN-L and CAN-H for your specific machine. Consult your machine documentation for more info, or see the next question to measure this out.

- **When do I have to add a termination resistor between CAN-L and CAN-H?**

Some machines already have an internal terminating resistor between the CAN lines. Follow the steps below to figure out how your machine is set-up.

- **CAN bus**

- Completely power off machine
- Measure resistance between CAN-H and CAN-L
- Measuring ~ 60Ω - No extra resistor required
- Measuring around 120Ω - Need additional 120Ω resistor between CAN-H and CAN-L on tracker side

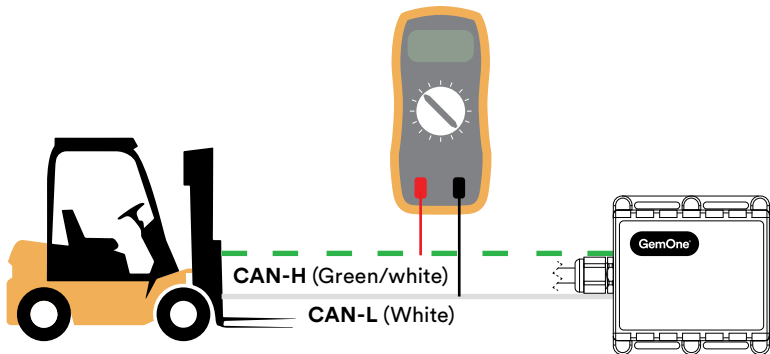

# Support

In case of issues, questions or feedback, feel free to contact our support team.

 +32 56 93 01 08

 [support@gemone.com](mailto:support@gemone.com)

## Save time with our connectors

Request for connectors for your machines to save time while installing this tracker. GemOne offers a multitude of different connectors. Get in contact with your account manager for an offer.



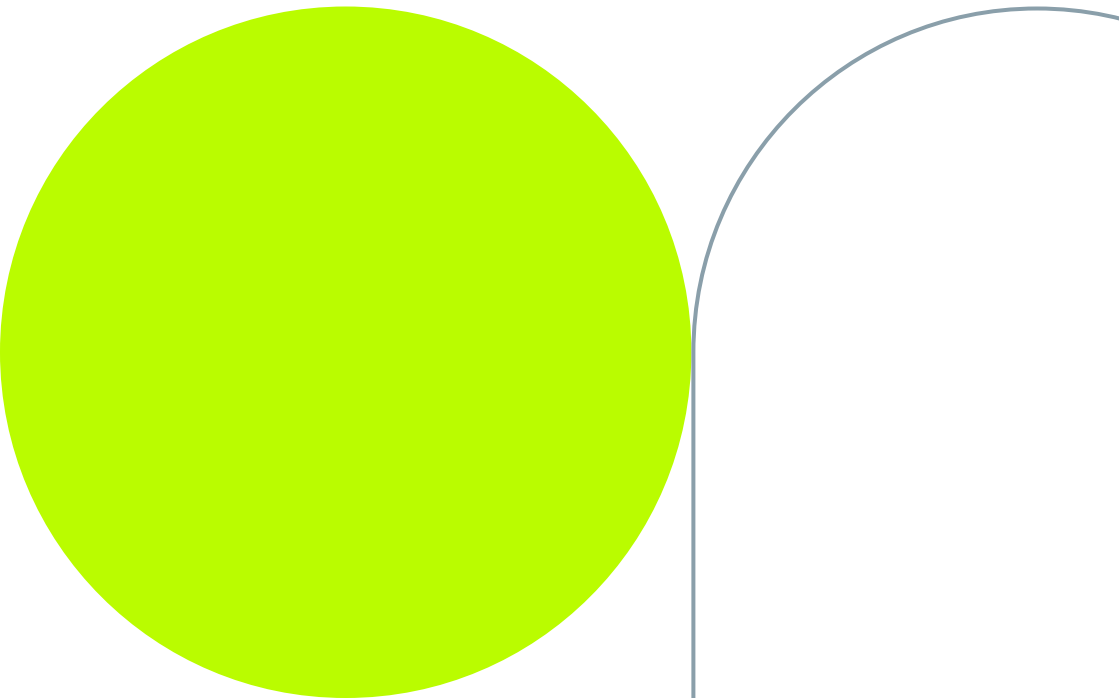

## Lets get connected:

- 📷 [instagram.com/gemoneofficial](https://www.instagram.com/gemoneofficial)
- 📘 [facebook.com/gemone.telematics](https://www.facebook.com/gemone.telematics)
- 🌐 [linkedin.com/company/gemone](https://www.linkedin.com/company/gemone)
- 🐦 [twitter.com/GemOne\\_](https://twitter.com/GemOne_)
- ✉️ [support\\_emea@gemone.com](mailto:support_emea@gemone.com)

**[www.gemone.com](http://www.gemone.com)**



©2021 - GemOne NV, Spinnerijstraat 99/23, BE-8500 KORTRIJK. All rights reserved. No part of this publication may be reproduced or communicated in any form or by any means, electronic or mechanical, including copying, recording or use in an information storage or retrieval system, without prior and explicit permission of GemOne NV. Photographs and illustrations are included for reference purposes only. GemOne is a registered brand.